

EAP767

INDOOR ACCESS POINT



INTRODUCTION

4ipnet EAP767 is an enterprise-grade, concurrent dual-band 802.11ac indoor access point, designed specifically for high-density environments such as offices, universities, hotels, and hospitals. Featuring two 3x3 MIMO radios that can support up to 450 and 1300 Mbps data rates in the 2.4 and 5 GHz bands respectively, the EAP767 is ideal for providing wire-like performance that is crucial for businesses. Traffic prioritization ensures that bandwidth hungry applications such as 4K videos can stream perfectly, while enforcing strict quality of service requirements for VoIP and mission critical services.

Given the overcrowding of the 2.4 GHz band by legacy Wi-Fi devices, more and more devices and networks are migrating to the 5 GHz band for increased performance. The wider channels and additional spatial streams offered by 802.11ac allows the EAP767 to meet high capacity demands while providing three-fold performance over 802.11n networks. However, due to the significant proportion of 2.4 GHz-only clients in use today, the EAP767's ability to service clients in both the 2.4 GHz and 5 GHz bands becomes essential for organizations that wish to improve overall wireless experience without sacrificing legacy support.

The EAP767's exterior is composed of a UL94-5VB rated, pearl-white plastic front panel and a metallic back plate – a simplistic and elegant design that is perfect for blending into everyday public or working environments. Furthermore, the camouflaged appearance of the EAP767 is accentuated by its six internal antennas, which serve to amplify wireless coverage. With two different mounting mechanisms, the EAP767 can be easily mounted on walls or ceilings. Combined with PoE (Power over Ethernet) support that eliminates the need for traditional power sources, the EAP767 offers unparalleled deployment flexibility.

When used with the 4ipnet WHG Controller, the EAP767 supports a wide-array of value added applications required by enterprises and organizations, such as bandwidth control, user authentication and billing, centralized WLAN management, and much more. Along with stringent yet customizable security policies, the flexible and fully-featured EAP767 becomes the ideal choice for all types of businesses, from small coffee shops to large corporations.

HIGHLIGHTS

- Concurrent dual-band 2.4 & 5 GHz
- 802.11ac 3x3 MIMO supporting up to 1300 Mbps data rate
- Ceiling mountable UL94-5VB fire-retardant plastic housing
- 802.3at Power over Ethernet (PoE) compatible
- Standalone or centrally managed by 4ipnet WHG Controller
- Integrated enterprise-grade, standards-based security
- Up to 16 ESSIDs per radio with 802.1Q VLAN
- Captive portal and Guest provisioning*¹
- Rogue AP detection & Load balancing*¹
- Fast Layer 2/Layer 3 roaming*¹

*¹: When used in conjunction with 4ipnet WHG Controller

FEATURES

Very High Throughput

The demand for 802.11ac is growing tremendously as enterprises and organizations seek to increase bandwidth and alleviate network congestion. With wider channel widths, an increased number of supported spatial streams, and more advanced modulation techniques, the 11ac-enabled EAP767 provides data rates significantly higher than that of 802.11n access points. Furthermore, each device can transmit the same amount of data in a much shorter period of time, improving overall network capacity and performance while ensuring smooth operation of sensitive network applications.

Ready for High Density Environments

With the ability to operate in the 2.4 and 5 GHz bands, the EAP767 can distribute clients on separate channels, thereby mitigating channel congestion. The EAP767 also implements advanced AP features such as airtime fairness, multicast to unicast conversion, and optimal client filtering, improving wireless performance in high density environments while ensuring uninterrupted access to mission critical resources and delay sensitive applications. Wireless QoS with standards-based 802.11e/WMM (Wi-Fi Multimedia) further guarantees a wire-like experience.

Maximum Deployment Flexibility

Supporting 802.3at PoE, the EAP767 can be placed in locations where traditional power sources are unavailable, such as high ceilings and walls. In addition, its plenum-rated materials allows it to be placed in ceiling areas safely without having to worry about being a fire hazard, further increasing deployment flexibility.

Enterprise-grade, Standards-based Security

With 802.1X authentication and a backend RADIUS server, the EAP767 can prevent unauthorized users from accessing the corporate intranet. Furthermore, the AP's Layer 2 firewall capability blocks unwanted traffic, reducing network overhead and providing an added layer of security. Finally, the AP can be configured with multiple SSIDs, each utilizing different security standards (e.g. WPA2-Enterprise) and VLAN tags, which enables easy network segmentation to protect corporate resources.

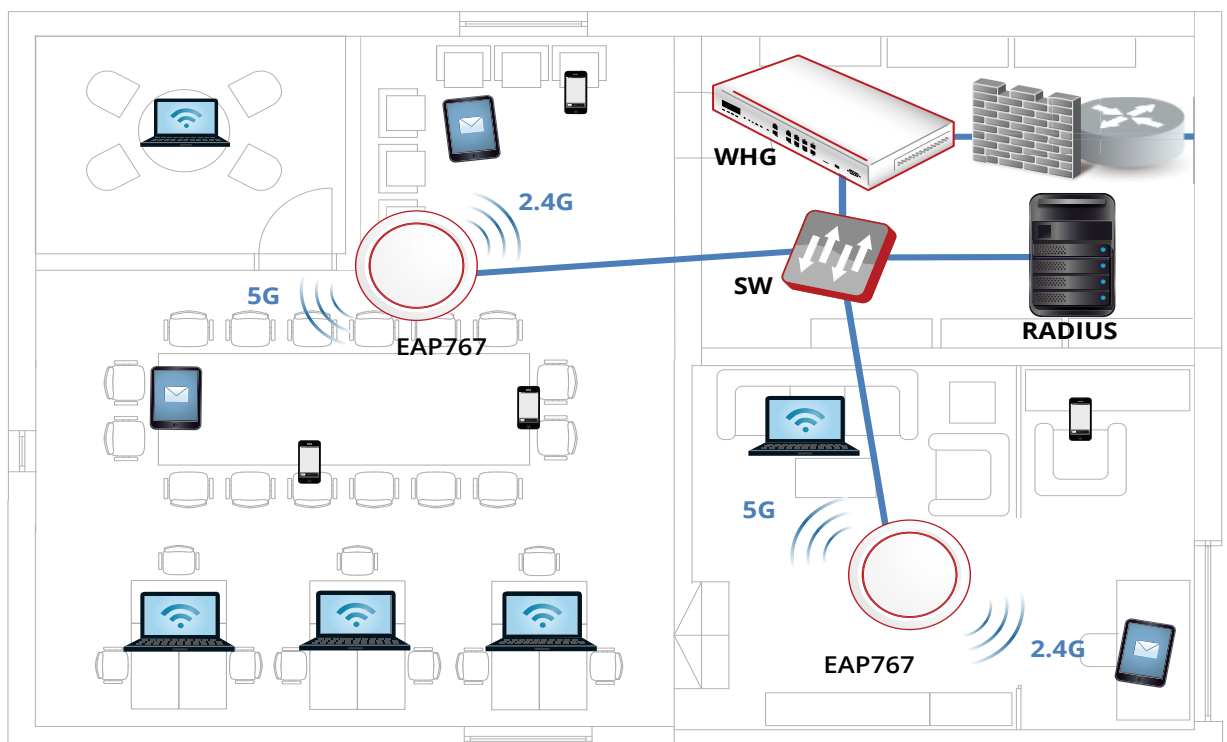

SPECIFICATIONS

PHYSICAL	
Power	<ul style="list-style-type: none"> DC Input: 12V / 2.5A (Power adapter optional) PoE: 802.3at compliant (PoE injector optional)
Dimensions	<ul style="list-style-type: none"> 18.0 cm (L) x 18.0 cm (W) x 4.4 cm (H)
Weight	<ul style="list-style-type: none"> 0.61 kg (1.35 lbs)
Interfaces	<ul style="list-style-type: none"> Uplink: 1 x 10/100/1000Base-T Ethernet, Auto MDIX, RJ-45 with 802.3at PoE
LED Indicator	<ul style="list-style-type: none"> Uplink
Environmental Conditions	<ul style="list-style-type: none"> Operating Temperature: -10°C (14°F) to 50°C (122°F) Operating Humidity: 10% to 90% non-condensing UL94-5VB Rating
Power Consumption	<ul style="list-style-type: none"> 17W max.
Antenna	<ul style="list-style-type: none"> Type: 6 x Built-in PIFA (3 x 2.4 GHz, 3 x 5 GHz) Gain: 3 dBi (2.4 GHz), 5 dBi (5 GHz)
Mounting	<ul style="list-style-type: none"> Wall mount (Mounting panel included) Ceiling mount (Ceiling mount kit included)

WI-FI	
Standards	<ul style="list-style-type: none"> 802.11 a/b/g/n/ac Concurrent dual-band 2.4 & 5 GHz
Supported Data Rates	<ul style="list-style-type: none"> 802.11b: 1, 2, 5.5, 11 Mbps 802.11a/g: 6, 9, 12, 18, 24, 36, 48, 54 Mbps 802.11n: 6.5 – 216.7 Mbps (20 MHz) 802.11n: 13.5 – 450 Mbps (40 MHz) 802.11ac: 6.5 – 260.1 Mbps (20 MHz) 802.11ac: 13.5 – 600 Mbps (40 MHz) 802.11ac: 29.3 – 1300 Mbps (80 MHz)
Radio Chains	<ul style="list-style-type: none"> 3 x 3
Spatial Streams	<ul style="list-style-type: none"> 3
Output Power	<ul style="list-style-type: none"> 2.4 GHz: Up to 25 dBm*1 5 GHz: Up to 25 dBm*1
Channelization	<ul style="list-style-type: none"> 20 MHz 40 MHz 80 MHz
Frequency Band	<ul style="list-style-type: none"> 2.412 – 2.472 GHz 5.180 – 5.825 GHz
Operating Channels	<ul style="list-style-type: none"> 2.4 GHz: 1 – 11 (US), 1 – 13 (Europe), 1 – 13 (Japan) 5 GHz*2: 36 – 165 (US), 36 – 140 (Europe), 36 – 140 (Japan)
ESSIDs	<ul style="list-style-type: none"> Up to 16 per radio (32 total)
Certifications	<ul style="list-style-type: none"> FCC (United States), CE (Europe), NCC (Taiwan)

PERFORMANCE	
Physical Data Rate	<ul style="list-style-type: none"> Up to 450 Mbps (2.4 GHz) Up to 1.3 Gbps (5 GHz)
Concurrent Users	<ul style="list-style-type: none"> Up to 384 (256 on 2.4 GHz, 128 on 5 GHz)

*1: Maximum power is limited by local regulatory requirements

*2: Some channels are restricted by local regulatory requirements

QUALITY OF SERVICE

- Wireless QoS (802.11e/WMM)
- DSCP (802.1p)
- Airtime Fairness
- Band Steering
- Multicast to Unicast Conversion
- Optimal Client Filtering

MANAGEMENT

- | | |
|---------------|--|
| Deployment | <ul style="list-style-type: none"> ♦ Standalone ♦ Tunneled management by 4ipnet WHG Controller ♦ IPv4 & IPv6 compatible |
| Configuration | <ul style="list-style-type: none"> ♦ Web User Interface (HTTP/HTTPS) ♦ SNMP v1, v2c, v3 |

SECURITY

- | | |
|-------------------|---|
| Wireless Security | <ul style="list-style-type: none"> ♦ WEP ♦ WPA/WPA2 Mixed ♦ WPA2-Personal ♦ WPA2-Enterprise (802.1X) ♦ TKIP and AES Encryption |
|-------------------|---|

VLAN Tagging (802.1Q)

Station Isolation

DHCP Snooping

Layer-2 Firewall

MOBILITY/ROAMING

802.1X Preauthentication

Layer 2/Layer 3 Fast Roaming

RECEIVE SENSITIVITY

Operating Mode	Data Rate	Receive Sensitivity (dBm)
802.11b	1 Mbps	-93
	11 Mbps	-85
802.11a	6 Mbps	-89
	54 Mbps	-73
802.11g	6 Mbps	-89
	54 Mbps	-73
802.11n (HT20)	MCS0	-88
	MCS7	-68
	MCS8	-88
	MCS15	-68
802.11n (HT40)	MCS0	-85
	MCS7	-67
	MCS8	-85
	MCS15	-67
802.11ac (VHT20)	MCS0	-89
	MCS8	-65
802.11ac (VHT40)	MCS0	-86
	MCS9	-60
802.11ac (VHT80)	MCS0	-84
	MCS9	-57

SIGNAL COVERAGE PATTERN

H-plane (Horizontal)

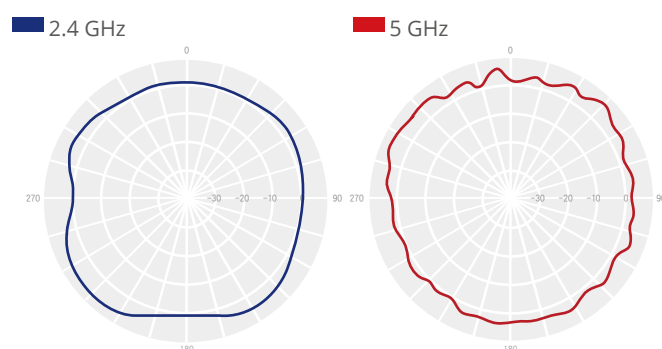

E-plane (Vertical)

